

Box-PC SYSTEM BPCWL02-i5WA Industry IoT

Core i5, 8 GB RAM, 250 GB SSD, Win 10 IoT

FANLESS SHUTTLE BOX-PC SYSTEM WITH INTEL CORE ULV PROCESSOR IN A ROBUST CHASSIS

Shuttle's new generation BPCWL0x IPC Series in a ruggedized box design for high durability consists of compact fanless IPC systems with modular expansion. BPCWL02-i5WA Industry is a fixed configuration with Windows operating system and a selection of pre-installed I/O extensions for a wide-range of industrial applications.

Images for illustration only

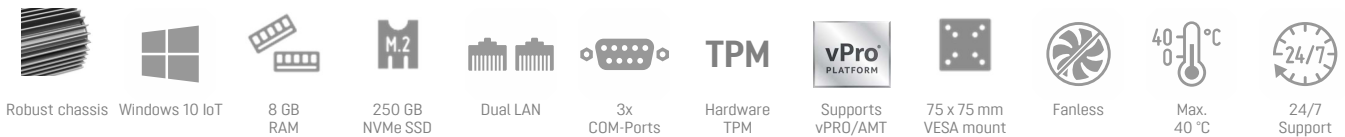

ROBUST CHASSIS

- Fanless cooling system ■ Robust aluminium/steel chassis
- Dimensions (LWH): 16.9 x 24.5 x 5.7 cm (2.7 L) ■ Net weight: 2.85 kg
- Operating temperature: 0 ~ 40 °C ■ Operating humidity: 0 ~ 90% (non-condensing) ■ IP Rating: IP30 ■ Mounting options: VESA 75x75 mm, Ear mount 256x100 mm and DIN Rail

OPERATING SYSTEM

- Windows 10 IoT Enterprise LTSC Value (64-Bit)

PROCESSOR

- Intel Core i5-8365UE, 4 Cores, 8 Threads, 1.6~4.1 GHz, 6 MB Cache
- "Whiskey Lake" ULV Prozessor, 15 W TDP
- Integrated Intel UHD 620 graphics

RAM / SSD

- 8 GB DDR4 RAM memory (2x 4 GB)
- 250 GB M.2-2280 SSD card (PCIe / NVMe)

FRONT PANEL CONNECTORS **)

- 2x COM (RS232/422/485) ■ 4x USB 2.0 ■ VGA D-Sub Port

BACK PANEL CONNECTORS

- HDMI 1.4 ■ 4x USB 3.2 Gen 1 ■ Dual Gigabit LAN (Intel i219LM/i211)
- COM (RS232) ■ Mic-in and Line-out (Realtek ALC662)
- DC-input (Wide range: 9~36V) ■ Power Button

OTHER FEATURES

- Hardware TPM v2.0 Infineon SLB9670VQ2 onboard
- AMI BIOS, 32 MB SPI ROM supports Intel vPro and ATM features

POWER SUPPLY

- External 90W/19V power adapter
- AC input 100~240V 50~60 Hz, 3-pin connector
- DC Input of the Box-PC supports wide voltage range: 9~36V

Overview Box-PC Series BPCWL0x:

Processor / BIOS	Barebone	BTO System**) without Windows	BTO System**) with Windows	Operating temp.	Power Adap.	UPC Code
Intel Core i3-8145UE 2.2~3.9 GHz, 2/4 Cores 16 MB BIOS without vPRO function	BPCWL02-i3	BPCWL02-i3X	BPCWL02-i3W	0 ~ +40 °C	90 W	887993003474
	BPCWL03-i3	BPCWL03-i3X	BPCWL03-i3W	-20 ~ +60 °C *)	150 W	887993004716
Intel Core i5-8365UE 1.6~4.1 GHz, 4/8 Cores 32 MB BIOS with vPRO function	BPCWL02-i5	BPCWL02-i5X	BPCWL02-i5W	0 ~ +40 °C	90 W	887993003481
	BPCWL03-i5	BPCWL03-i5X	BPCWL03-i5W	-20 ~ +60 °C *)	150 W	887993004723

*) the BPCWL03 Series (-20 ~ +60°C) requires industrial-grade RAM modules and M.2 SSDs with an operation temperature range of -40 to +85°C.

***) the BTO-Systems allow a customized configuration of the front panel with connectors such as HDMI 2.0, DisplayPort, VGA, USB 2.0 und COM ports.

Fixed Configuration	Processor	OS	M.2-SSD	RAM	Operating temp.	EAN Code
BPCWL02-i3XA Industry	Intel Core i3-8145UE	None	120 GB	4 GB	0 ~ +40 °C	4046047103652
BPCWL02-i5WA Industry IoT	Intel Core i5-8365UE	Windows 10 IoT	250 GB	8 GB	0 ~ +40 °C	4046047103669

Front and Back Panel

Front panel



1. Dual COM ports support RS232/RS422/RS485
2. 4x USB 2.0 port
3. D-Sub VGA port

Back panel

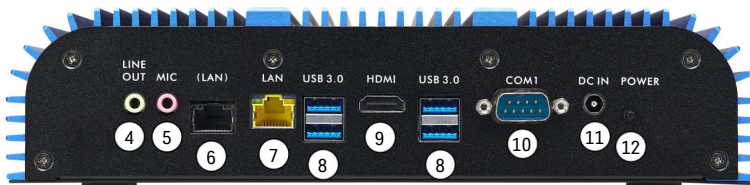

4. Audio Line Out (Headphones output)
5. Microphone input
6. Gigabit LAN port (Intel i211)
7. Gigabit LAN port (Intel i219LM)
8. 4x USB 3.2 Gen 1 Type A port
9. HDMI 1.4 port
10. COM port (RS232)
11. DC-in connector for power adapter
12. Power button

Dimensions

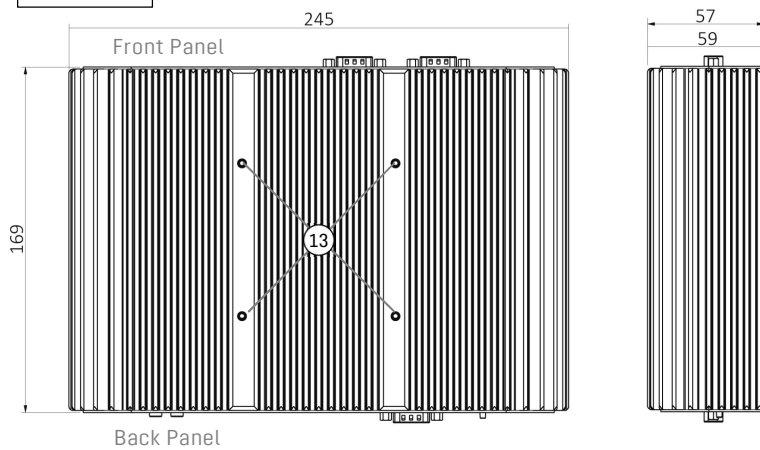

13. Screw threads for VESA mount (75x75 mm)

Dimensions:

Width: 245 mm (without optional ear mount)
 Depth: 169 mm
 Height: 57 mm (59 mm including feet)

Operating Positions and Mounting

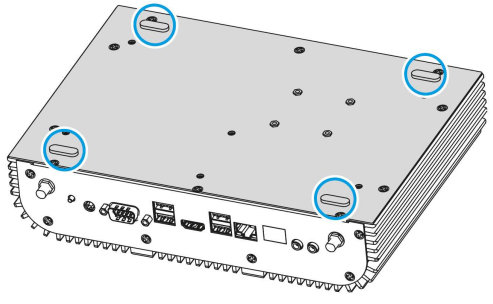
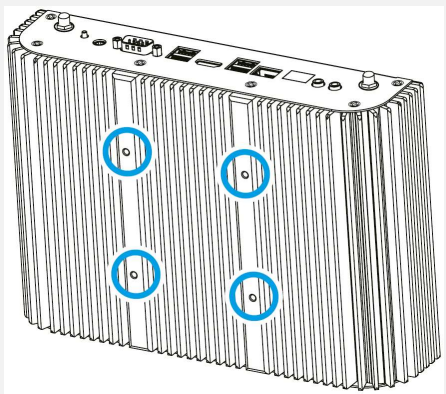
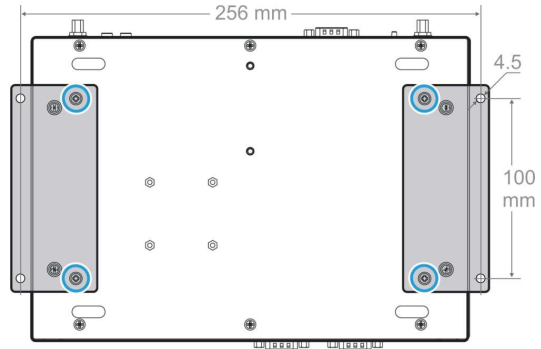
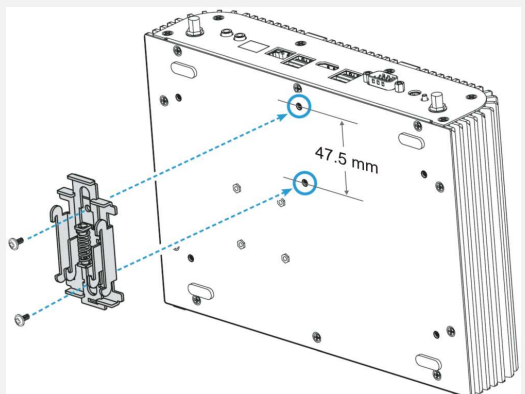
	NOTE	IMAGE
Placed horizontally	The Shuttle Box-PC BPCWLOx can be operated in horizontal position like a desktop PC standing on its rubber feet.	
VESA-mounted	The Shuttle Box-PC BPCWLOx features four threaded M4 holes on the upper side for a standard 75 x 75 mm VESA mount, which allows for installation on to walls or large displays. The VESA mount is not included.	
Ear-mounted	The Shuttle Box-PC BPCWLOx features four threaded M3 holes on the bottom, which allows for it to be attached to two Ear Mount brackets (optional accessory). The Box-PC can then be affixed to a surface with four M4 screws (mounting dimension: 256 mm x 100 mm).	
DIN-Rail-mounted	The Shuttle Box-PC BPCWLOx features two threaded M3 holes on the bottom, which allows for installation on a standard 35 mm DIN-Rail, e.g. inside equipment racks. The DIN-Rail clip is not included.	

SHUTTLE Box-PC System BPCWLO2-i5WA Industry IoT – SPECIFICATIONS

FANLESS AND SILENT	Equipped with passive cooling, no fan noise at all Perfect to be used in noise-sensitive environments Fanless, dust-free and thus virtually maintenance-free
24/7 NONSTOP OPERATION	This device is approved for 24/7 permanent operation. Requirement: Free circulation of air amongst the PC must be guaranteed.
CHASSIS	Durable and rugged chassis made of aluminium and steel. Passive cooling system with specially designed fins to maximize heat dissipation. Dimensions: 16,9 x 24,5 x 5,7 cm (LWH) = approx. 2,7 litres Weight: ca. 3.0 kg net IP-rating: IP30
OPERATING POSITIONS AND MOUNTING	1) The unit can be placed horizontally to stand on its feet. 2) The unit can be affixed to a 75 mm x 75 mm VESA bracket. For this purpose, four M4x6L screws are required to be screwed into the chassis from the top. 3) The unit can be mounted using two optional 256 mm x 100 mm ear-mount brackets. For this purpose, four M3x6L screws are required to be screwed into the chassis from the bottom. 4) Mounted on a standard 35 mm DIN-Rail, e.g. inside equipment racks <u>Notes:</u> VESA bracket, Ear-Mount and DIN-Rail clip are not included. Vertical mounting is permitted in any orientation.
OPERATING SYSTEM	Windows 10 IoT Enterprise LTSC Value (64-bit)
PROCESSOR	Model: Intel Core i5-8365UE (ULV) System-on-a-chip architecture (SoC) with integrated memory and graphics controller FCBGA1528 package - directly soldered onto the mainboard Code name: Whiskey Lake-U (8th Generation Intel Core) Cores / Threads: 4 / 8 Clock rate: 1.6 GHz, Turbo clock rate: 4.1 GHz L3 Smart Cache: 6 MB TDP wattage: 15 W maximum Manufacturing process: 3rd-generation enhanced 14nm++
INTEGRATED GRAPHICS	Intel UHD Graphics 620 GPU clock frequency: 300~1050 MHz Execution Units (EUs): 24 This Box-PC supports two independent screens via HDMI 1.4 and VGA.
UEFI BIOS	Supports resume after power failure Supports Wake on LAN (WOL) Supports Power on by RTC Alarm Supports boot from M.2 SSD cards and USB devices AMI BIOS in 32 MB EEPROM with SPI interface Supports hardware monitoring and Watchdog function Supports Unified Extensible Firmware Interface (UEFI)
INTEL vPRO/AMT	Supports Intel® vPro™ and AMT Intel® vPro™ is a brand name for a specific set of management and security technologies. Intel® Active Management Technology (AMT) is a subset of Intel vPro. This technology allows remote management of PCs, even in power-off mode or with non-functional operating systems. You can audit, repair and restore AMT-based platforms in a LAN. These functions can increase the uptime of desktops with lower maintenance costs. <u>Note:</u> Intel vPro requires appropriate software. The Intel® MEBX configuration user interface can be accessed after pressing CTRL-P at the beginning of the boot process. Only the Intel i219 LAN port (yellow color) supports the Intel vPro® function.
TPM MODULE	Hardware Trusted Platform Module (Infineon SLB9670VQ2 TPM 2.0)
POWER ADAPTER	External 90 W power adapter (fanless) Input: 100~240 V AC, 50/60 Hz Output: 19 V DC, 4.74 A, max. 90 W DC Connector: 5.5/2.5 mm (outer/inner diameter) AC mains cable: 3 pins, ca. 1.8 m length, with C5/C6 coupler (called "Mickey Mouse" or "Clover-leaf") for the power adapter and CEE-7/7 plug with earth-contact (type E+F) for the power outlet
DC-INPUT: 9~36V	DC input supports wide voltage range: 9~36 V DC Input connector: 5.5 / 2.5 mm (outer/inner diameter)

RAM MEMORY	8 GB DDR4 SO-DIMM memory (260-pins) Supports a maximum of 32 GB per DIMM, maximum total size: 64 GB
M.2 SSD	250 GB SSD card in M.2-2280 form factor Supports PCI-Express with NVMe
AUDIO	Audio Realtek® ALC662 or ALC888S High-Definition Audio Two analog audio connectors (3.5 mm) on the back panel: 1) 2 channel line out (headphones) 2) microphone input Digital multi-channel audio output: via HDMI and optional DisplayPort
DUAL GIGABIT LAN	Dual network with two RJ45 ports Used network chips: 1) Intel i211 Ethernet Controller with MAC, PHY and PCIe interface 2) Intel i219LM PHY connected to the MAC of the processor Supports 10 / 100 / 1000 MBit/s operation Supports WAKE ON LAN (WOL) Supports network boot by Preboot eXecution Environment (PXE) Supports Teaming mode
BACK PANEL CONNECTORS	Power Button HDMI 1.4 4x USB 3.2 Gen 1 Type A (max. 5 Gbps) 2x Intel Gigabit LAN (RJ45, i211/i219LM) Serial COM port (RS232) Microphone input (3.5 mm) Audio Line-out / Headphones (3.5 mm) DC-input connector for external power adapter (DC input supports 9~36V)
FRONT PANEL CONNECTORS	2x COM port (supports RS232/422/485) 4x USB 2.0 1x VGA D-Sub Port
OPTIONAL ACCESSORIES	1) Ear-mount brackets (mounting dimensions: 256 mm x 100 mm) 2) WLAN 802.11n/ac and BT 4.0 (RTL8821CE) with two external antennas
ENVIRONMENTAL SPECIFICATIONS	Operating temperature range: 0~40 °C Relative humidity, non-condensing: 0~90 %
CONFORMITY AND CERTIFICATIONS	EMI: CE, FCC Class A, VCCI, RCM, BSMI Safety: CB, cTUVus, BSMI Other: RoHS, ErP, CEC This device is classed as a technical information equipment (ITE) in Class A, Class A is for product used in commercial and industrial areas. The CE-mark approves the conformity by the EU directives: (1) 2014/30/EU relating to electromagnetic compatibility (EMC), (2) 2014/35/EU relating to Electrical Equipment designed for use within certain voltage limits (LVD), (3) 2009/125/EC relating to eco design requirements for energy-related products (ErP)